

ALFALINE

Wall Mounted Cabinets

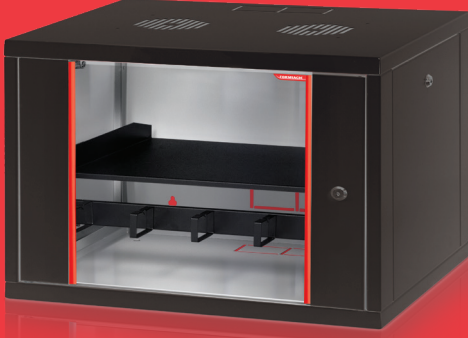

- The front and side covers are openable, lockable and easily removable
- The rear cover is made by high strength 1,2 mm DKP sheet that provides high strength with holes for wall mounting
- Ventilation is provided by cooling units with 1 or 2 fans.
- Cabinets have cable entries from 3 different points on the bottom frame, top frame and rear cover.
- If required, it can be used as a floor type by attaching a fixed foot or castor.
- Painted by impact-resistant, high strength, electrostatic Ral 7035 texture gray color (Ral 9005 optional).
- All test procedures have been carried out and has ROSH, CE, EN 61587-1 standards.

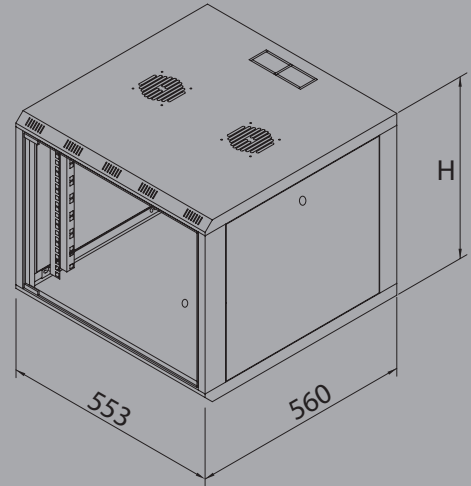

19" 600 x 560 Wall Mounted Cabinet Genişlik - Width: 555 mm / Derinlik - Depth: 560 mm

Order No	U	h	H	KG
FORM ALFA-16U560	16	673	731	28

U: Unit (1U=44,45mm) / h: İç Yükseklik - Inside Height (mm) / H: Tekerlek Dahil Dış Yükseklik - Outside Height (mm)